

Name : _____

Score : _____

Teacher : _____

Date : _____

Volume of Prisms, Pyramids, Cylinders, and Cones

Find the volume of each figure. Round answers to the nearest hundredth, if necessary.

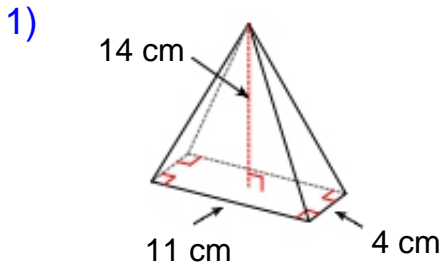

Volume: _____

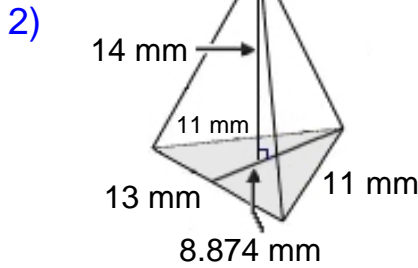

Volume: _____

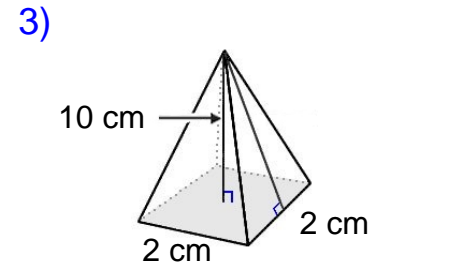

Volume: _____

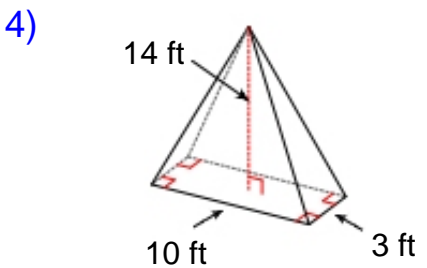

Volume: _____

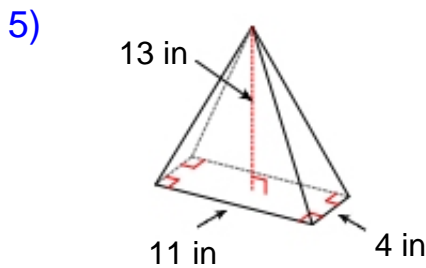

Volume: _____

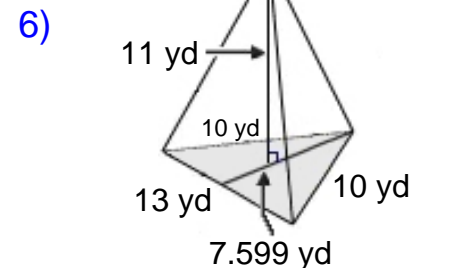

Volume: _____

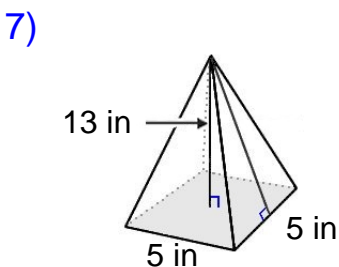

Volume: _____

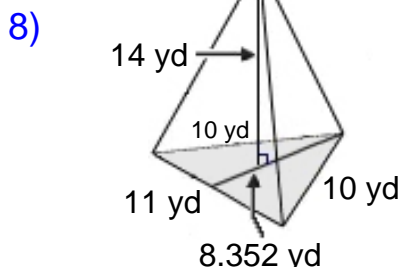

Volume: _____

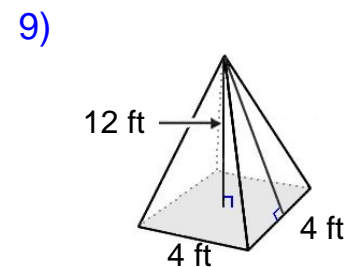

Volume: _____



Name : _____

Score : _____

Teacher : _____

Date : _____

Volume of Prisms, Pyramids, Cylinders, and Cones

Find the volume of each figure. Round answers to the nearest hundredth, if necessary.

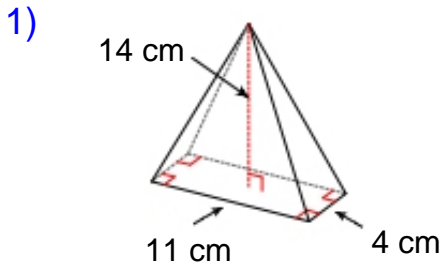

Volume: 205.33 cm³

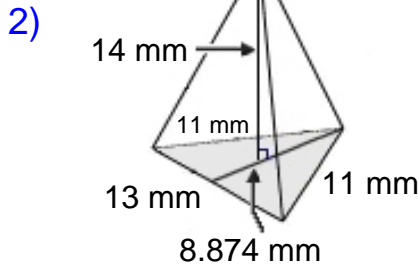

Volume: 269.18 mm³

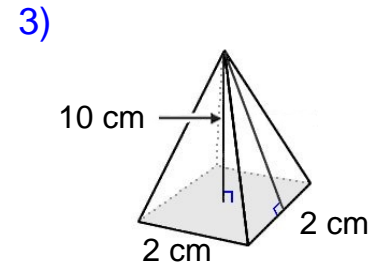

Volume: 13.33 cm³

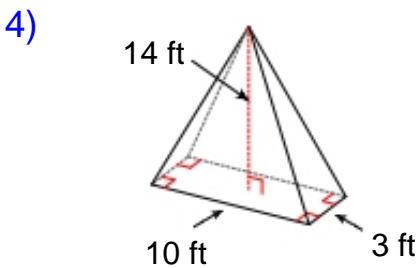

Volume: 140.00 ft³

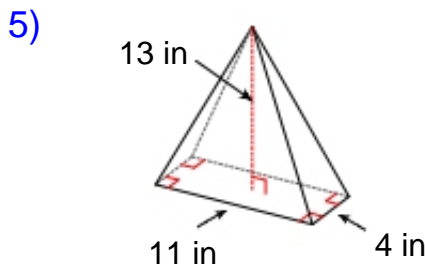

Volume: 190.67 in³

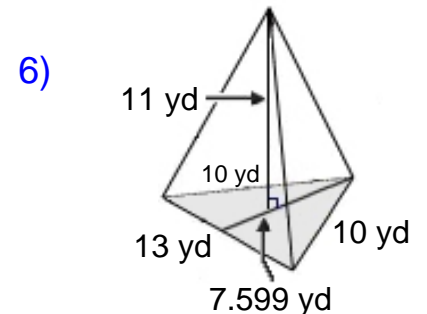

Volume: 181.11 yd³

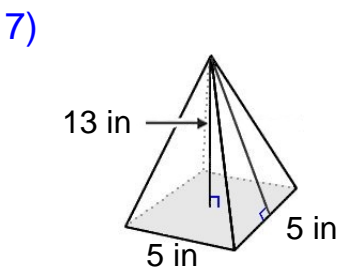

Volume: 108.33 in³

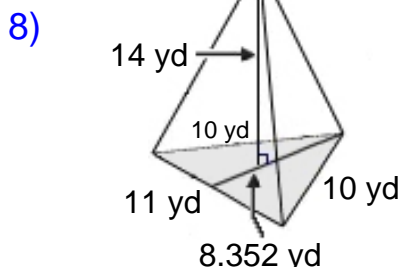

Volume: 214.37 yd³

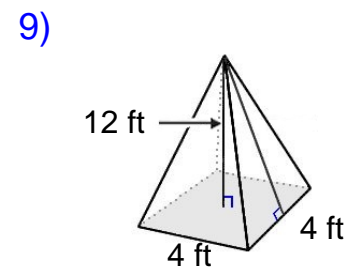

Volume: 64.00 ft³

